

Build This *Easily Regulated* Power Source

...for your Electronic Laboratory !!!

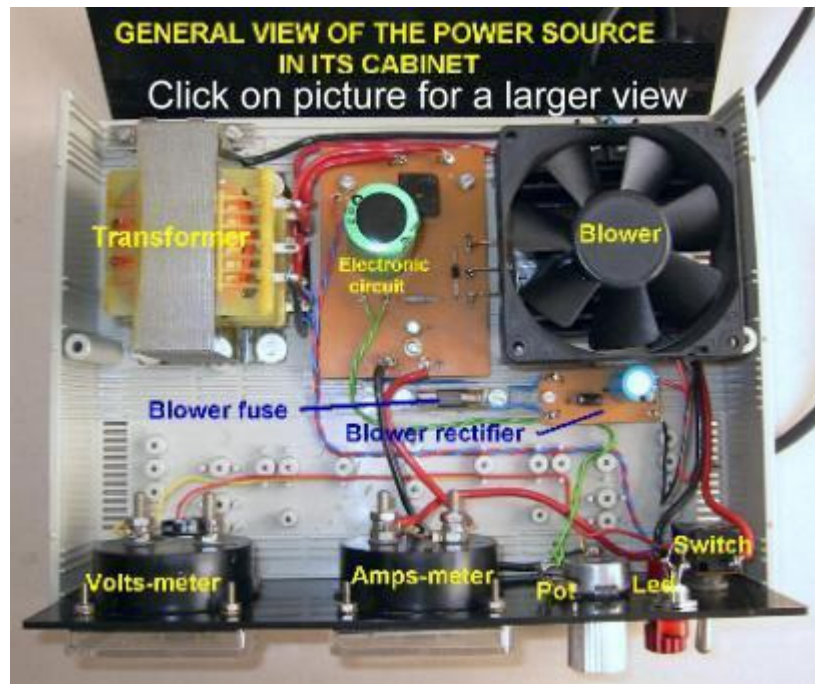

A regulated power source is not only an instrument that supplies direct current to your circuits at the desired level...it also allows you to have a previous idea about how the circuit operates. Having a volt-meter and an ampere-meter at the output of the unit, one knows immediately if there is a short or open circuit in the circuitry layout. And you would know first hand, if the current is excessive or too feble at the set-up voltage.

We now have excellent IC's (integrated circuits) that makes the building of a power source quite easy. Among these IC's, you can choose different output power levels...

LM 317 - 1.5 Amps Output

LM 350 - 3.0 Amps Output

LM 338 - 5.0 Amps Output

The Schematic Diagram of the Regulated Power Source

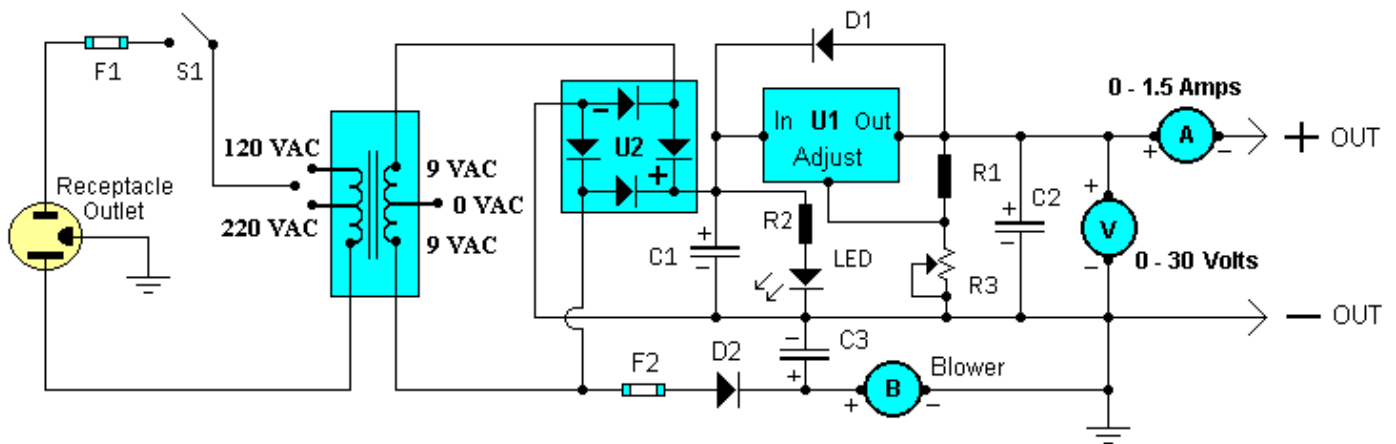

COMPONENT VALUES/RATINGS

(PLUS A FEW ITEMS NEEDED)

F1 - 2A fast acting fuse	R3 - 4700 Ohms Potentiometer
F2 - 250mA fast acting fuse	C1 - 4700uF/35v
S1 - SPST (Single Pole Single Throw) Switch	C2 - 1uF/35v
T1 - Transformer 3 Amp (Primary 120/220 VAC/Secondary 9-0-9 VAC)	C3 - 1000uF/35v
U1 - LM 317 Voltage Regulator IC	One heatsink with a surface area of at least 3 inches by 3 inches.
U2 - Bridge Rectifier 4A 100PIV	One Voltmeter with a range from 0 to 30 VDC.
R1 - 220 Ohms 1/2 Watt	One Ampmeter with a range from 0 to 1.5 Amps.
R2 - 1700 Ohms 1/2 Watt	Items needed will be one suitable metal or plastic cabinet. Plus bolts, nuts, washers and hook-up cable of different calipers and colors.

Picture List of Components ~ Circuitry Layout

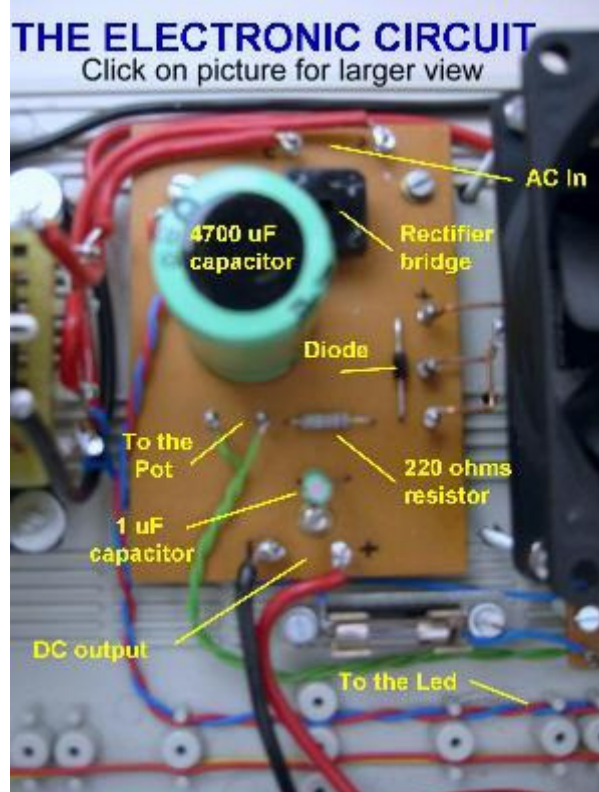
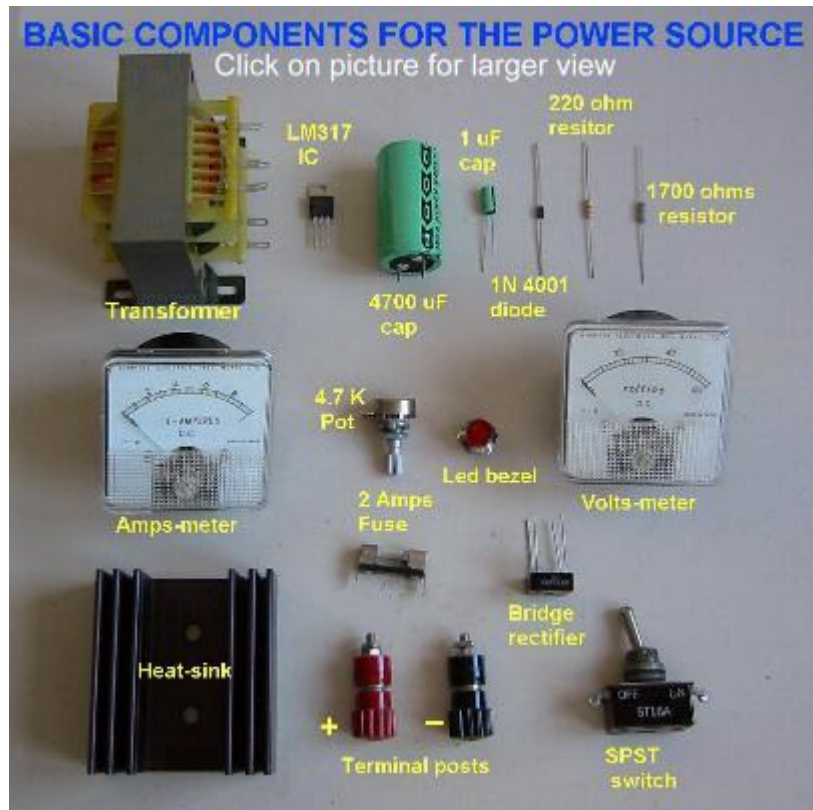

THE TRANSFORMER

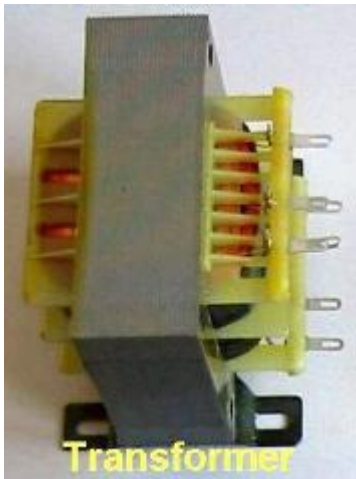

First, it is important to have a good transformer! That is, a transformer that does not get heated when the unit is working for a long time. My transformer has two entrance inputs; one 220 VAC and the other for 120 VAC. The transformer outputs can deliver up to 3 amps, though I limit the power source only to 1.5 amps. The two outputs are 9 - 0 - 9 volts...allowing you to connect them in series to get 18 volts...or in parallel to get a stronger current. I used the '18 volt' connection.

THE IC AND HEATSINK

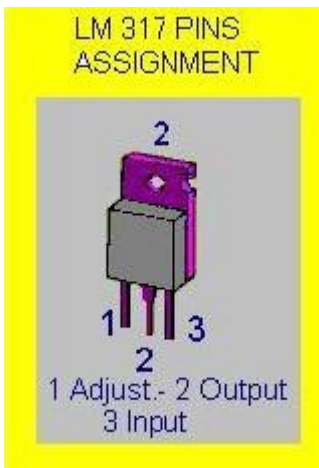

The transformer is the heart of the power source. Though of the same importance is LM317 integrated circuit. This IC can be obtain under two forms of packages: TO-3 and TO-220. Using the latter package, the mechanical work to mount it on the heatsink is much simpler.

The TO-3 package has the form of a power transistor. The output of the TO-3 is the same body of the package, so if you use the metal box of the power source as a heatsink, you have to isolate the IC by a mica washer. But to avoid all of this, I used the TO-220 package and an independent heatsink. As I built the unit into a plastic cabinet, all the problems of isolation of the LM317 IC dissapeared. You can use either

package...though the TO-3 involves more mechanical work !

The LM 317 IC without a big aluminium heatsink (at least 3 x 3 inches), to dissipate the heat generated when the unit is working, will get ruined in a very short time. Use silicon grease between the IC and the metal heatsink to assure a proper transmission of heat. That is why I provided a big heatsink for the project ☐

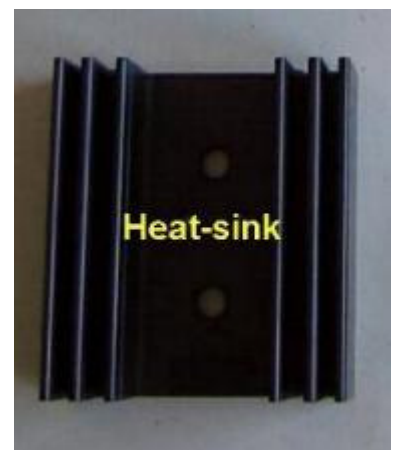

THE BLOWER

...and placed a blower above the heatsink to increase heat dissipation. The blower is one of those fans used in computers. It needs 12 VDC and takes only 150 milli-amps from the transformer. To drive the blower, I built a rectifier with a silicon diode and a capacitor. Together, the blower and rectifier work at ease in maintaining a coolness on the power source...even when taking on higher currents.

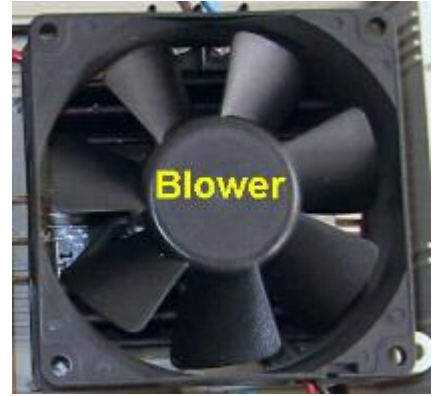

THE METERS

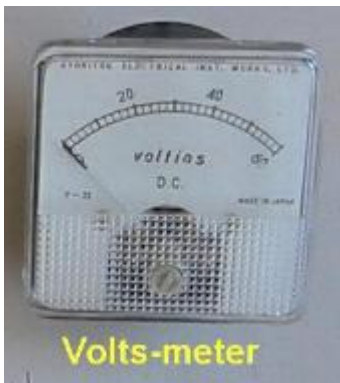

Volts-meter

At the output of the power source there is a voltmeter (0 to 30 volts) and an ampere-meter (0 to 1.5 amps). You can salvage these meters from discarded electronic devices. Or you can use meters from other projects you have previously made. **But make sure the ranges of the instruments are geared to the voltages/currents you are measuring !**

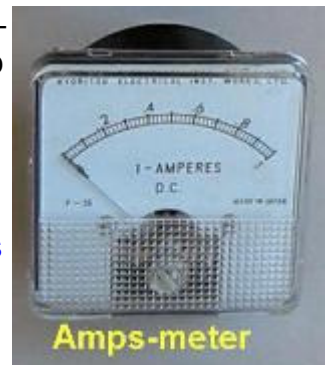

Amps-meter

If your ampere-meter is of a lesser range than 1.5 amps, it is a MUST to use a resistive shunt in parallel with the instrument to derive the excess of current. On the contrary, the coil on the ampere-meter will burn!

Testing the Voltmeter and Ammeter

Be careful with these delicate meters. Their price of purchase is fairly substantial!

Once the project is finished and everything is in its' right place into the cabinet... now is the time for the FIRST TEST. Before anything, we have to be sure that the entrance connection to the transformer is correct. Household receptacle outlets in the USA are 120VAC and most of the European countries are 220VAC. Now we need a load to check if the source delivers energy; voltage and current. Any resistor could be used among the ranges of 0 to 30 volts and 0 to 1.5 amps...according to Ohm's Law. But to avoid making mathematical operations, I used a bulb of 12 volts and 15 watts. These are typical bulbs used in automobiles. This is the best load for the test. With the power source unit in the 'OFF' position, be sure that the potentiometer is at its' minimum level, then switch the unit to the 'ON' position. The voltmeter will be at 1.2 volts dc...more or less, and the ampmeter practically at zero amps. Connect the bulb in its' socket to the



TESTING THE CURRENT DELIVERED BY THE POWER SOURCE WITH A 12 VOLTS CAR BULB

Click on picture for a larger view

terminal posts of the source. Then, slowly turn the potentiometer to increase the voltage, watching at the same time the needle in the voltmeter. The filament bulb will start getting red and slowly reach its' full brilliance. Don't force this brilliancy or the bulb will pass away. At the same time check the needle of the ampmeter. Don't allow this needle to reach the right top portion on the meter face.

Calibration of the Voltmeter and Ampmeter

Building this power source unit provides your electronic workbench with a very useful tool. But this tool has to be reliable. So some more critical tests must be performed. We need a precision instrument to check the voltmeter and ampmeter. Testing the power source voltmeter is quite easy using a DVM (Digital Volt Meter).

Set the DVM in the DC Volts position in the range from zero to a value superior to 30 volts. Connect the DVM leads directly to the terminals of the source and with respect to their polarities. Then slowly move the potentiometer to have the needle on the voltmeter adjust to 5VDC. Check and see if this figure is the same as shown on the screen of the DVM. Repeat this operation to various voltages...to be sure that the source voltmeter shows the same values as shown on the screen of the DVM. If all is OK, you know you have your source voltage instrument calibrated.

Now we proceed with the ampmeter. Again, we need a load resistor, which would be the 12 volt/15 watt bulb used in the previous test. Set the DVM in the amps' position and chose an appropriate range...for example, from zero to 10 amps, making sure it is always superior to 1.5 amps. **But be careful, an ampmeter must be connected in a different way as to the voltmeter. Be careful indeed, because an ampmeter is ALWAYS connected in SERIES with the load through which the current flows. Don't hook up the leads of your DVM, when measuring 'currents', directly to the terminals of the power source. This will BLOW the fuse of the DVM, or if the fuse endures this error, you have ruined your expensive DVM!** First, turn the potentiometer to its' minimum value. Now connect a pole of the bulb to the positive source terminal. The other pole of the lamp to the positive lead of the DVM...and the negative lead of the DVM to the negative terminal of the source. That is to say, you form a SERIES CIRCUIT with the bulb and the DVM to measure the current that flows through the lamp. Then turn the potentiometer slowly...increasing the voltage. Observe that the lamp filament starts getting red and the current increases as shown by the source ampmeter. Adjust to a current of 500mA and check to see that the figure is registering the same on the DVM screen. Followed by a re-adjustment of 1000mA (1 Amp) and also check to see that both measurements are equal. If that occurs, your ampmeter is calibrated. **When performing this last test, be careful not to burn the lamp with excessive current.** If these tests to the source voltmeter and the ampmeter are satisfactory, you have built a confident and reliable power source !

Building this power source is a real pleasure for its' simplicity. The results are the same as that of a commerical one. If everything has gone well, congratulate yourself...

...your power source has come to life !!!